

# RAIL 4 WET S4W-D

SOLID STEM . DIRECT

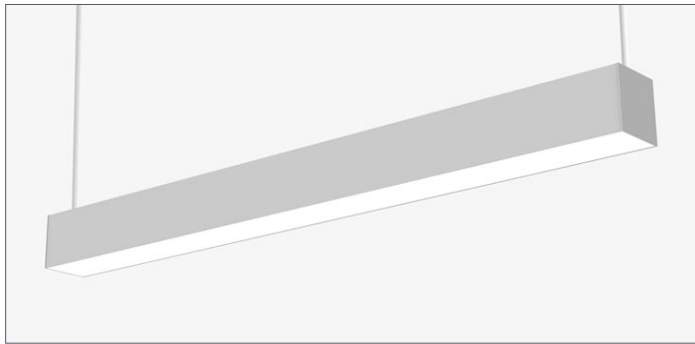

- Wet location and IP54 rated
- Continuous direct optics with no breaks
- Constructed of non-corrosive components
- Standard natatorium powder coat finish



PART #:	
PREP BY:	DATE:
PROJECT:	QTY:
NOTES:	
APPROVAL SIGNATURE:	DATE (DD/MM/YYYY):

PERFORMANCE SUMMARY @ 3500K		Meta Blanc (MB)	Polycarbonate (PC)
Light Level		<b>50</b>	<b>50</b>
Lumens per foot	80 CRI	574	585
	90 CRI	502	512
Wattage per foot		5.7	5.8
Efficacy	80 CRI	100	102
	90 CRI	88	88
L70 Estimate (h)		≥ 60,000 hrs	

See page 2 for the complete Light Level Performance chart.

## OTHER RAIL WET SERIES PRODUCTS

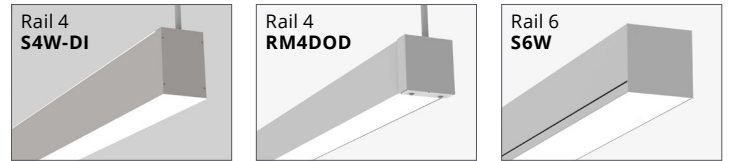

## ORDERING LOGIC

Example Part Number: S4W-D-35K-8-MB-NW-1001-SS18-3-OO-90

S4W-D								SS											
1	2	3	4	5	6	7	8	9	10	11									
1. SERIES <b>S4W-D</b> Direct	2. COLOR TEMP <b>30K</b> 3000K <b>35K</b> 3500K <b>40K</b> 4000K <small>90 CRI is available under OPTIONS</small>	3. LENGTH <b>3</b> 3 ft   <b>8</b> 8 ft <b>4</b> 4 ft   <b>9</b> 9 ft <b>5</b> 5 ft   <b>10</b> 10 ft <b>6</b> 6 ft   <b>11</b> 11 ft <b>7</b> 7 ft   <b>12</b> 12 ft <b>RA</b> Continuous Rows (Replace "A" with length in feet) <b>C</b> Custom Length*		4. OPTICS <b>MB</b> Meta Blanc <b>PC</b> Polycarbonate  <b>Meta Blanc:</b> Opal diffuse <b>Polycarbonate:</b> Semi-diffuse		5. NATATORIUM FINISH <b>NSA</b> Satin Aluminum <b>NW</b> White <b>NB</b> Black <b>NC</b> Custom Specify RAL:		6. LIGHT LEVEL / DRIVER <b>35</b> 350 lm/f <b>50</b> 500 lm/f <b>75</b> 750 lm/f <b>100</b> 1000 lm/f <b>C</b> Custom Range Specify lumens:  <small>(Total lumens between 350-1000 at 50 lm intervals)</small> Select Driver below. See Light Level Performance chart on p2.		7. CIRCUITRY <b>1</b> 1 Circuit <b>EM</b> Emergency / Night Light <b>B</b> Emergency Battery Pack* (limited to ambient temperatures down to 0°C)		8. MOUNTING <b>SSA</b> Solid Stem  Replace "A" with length in inches selected below. Select Solid Stem Length, Canopy Finish & Power Cord Color below		9. VOLTAGE <b>1</b> 120V <b>2</b> 277V <b>3</b> 347V <b>4</b> UNV (120 - 277V)		10. CONTROLS <b>OO</b> Outdoor Occupancy Sensor <b>_</b> None (leave space empty)		11. OPTIONS <b>90</b> 90 CRI, High R9 <b>_</b> None (leave space empty)	

\*Consult factory.

### Select Driver:

- Factory option 0-10V, 1% Dimming
- LHE** Lutron H-Series Hi-lume 1% EcoSystem LED Driver
- LSE** Lutron 5-Series EcoSystem LED Driver

### Select Solid Stem Length - 1/2" OD Standard:

Standard supplied length is 18" (460mm). Hangers will be supplied at closest length. All other lengths are considered custom unless otherwise stated. **If no selection is made, 48" will be supplied.**

Select:	Imperial (in)	Metric (mm)
<input type="checkbox"/>	<b>12</b>	305
<input type="checkbox"/>	<b>15</b>	380
<input type="checkbox"/>	<b>18</b>	460
<input type="checkbox"/>	<b>21</b>	533
<input type="checkbox"/>	<b>24</b>	610
<input type="checkbox"/>	<b>27</b>	685
<input type="checkbox"/>	<b>30</b>	760

Select:	Imperial (in)	Metric (mm)
<input type="checkbox"/>	<b>33</b>	840
<input type="checkbox"/>	<b>36</b>	915
<input type="checkbox"/>	<b>39</b>	990
<input type="checkbox"/>	<b>42</b>	1067
<input type="checkbox"/>	<b>45</b>	1145
<input type="checkbox"/>	<b>48</b>	1220
<input type="checkbox"/>	Custom Length (in inches):	_____

### Select Canopy Finish & Power Cord Color

Canopy	Power Cord
<input type="checkbox"/> White	<input type="checkbox"/> White
<input type="checkbox"/> Black	<input type="checkbox"/> Black
<input type="checkbox"/> Custom Finish	
RAL: _____	

## Light Level Performance

3500K, 80 CRI, 0-10V Dimming

Light Level	Meta Blanc (MB)			Polycarbonate (PC)		
	Lumens per foot	Wattage per foot	Efficacy (LPW)	Lumens per foot	Wattage per foot	Efficacy (LPW)
<b>35</b>	381	3.9	99	388	3.9	101
<b>50</b>	574	5.7	100	585	5.8	102
<b>75</b>	790	8.1	97	807	8.1	99
<b>100</b>	1090	11.8	93	1114	11.7	95

### Lumen Adjustment Factor

Color Temp	80 CRI	90 CRI
3000K	0.984	0.880
3500K	1.000	0.875
4000K	1.032	0.879

Metalumen's light level performance metrics are subject to manufacturers component tolerances.

## HANGER

Aircraft Cable & Cord

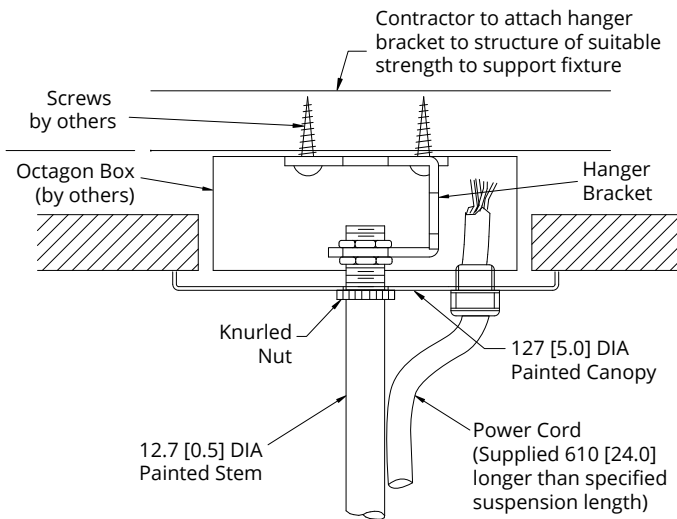

## WIRING

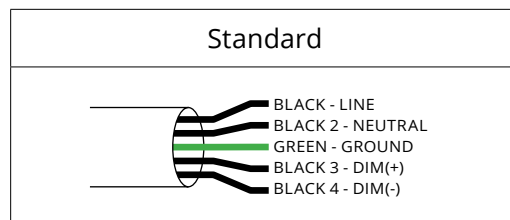

CROSS SECTIONS

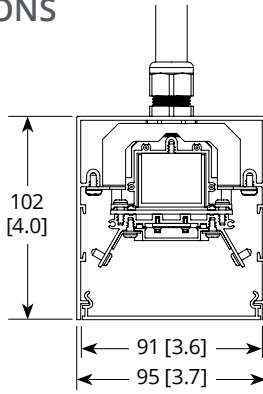

SPECIFICATIONS

Due to the Continuous Improvement Policy at Metalumen, we reserve the right to change our specifications without notice.

**Housing:** Rigid extruded aluminum body, 2.0mm (0.08”) nominal wall thickness. Aluminum formed end caps.  
**Optical System:** Metalumen luminaires are designed to utilize leading edge LED technology combined with luminaire optimized reflectors and our custom diffusers, resulting in industry leading optical performance.  
**CRI:** 83+ for 3500K, 80 minimum for all

CCTs in standard configurations.  
**Lumen Maintenance:** Minimum 50,000h with TM-21 lumen maintenance of 85% @ 25°C ambient temperature (calculated based on IESNA LM-80-08 LED test data). L70: ≥ 60 000hrs.  
**Finish:** Standard natatorium powder coated finish in satin aluminum, white and black. For custom colors, contact factory.

**Weight:** 3 lb/ft  
**Mounting:** Solid stem mount.  
**Drivers:** Metalumen offers dimming\* drivers as a standard on our entire LED product offering at 0-10V. Dimming range is 1%-100%. Power factor is > 90%. Class 2 rating. Drivers are integral.  
**Approvals:** All components are UL/CSA/QPS recognized or listed. RoHS compliant. This product is cULus listed.

**Environment:** Suitable for wet locations -22°F / -30°C start ambient temperature. Suitable for natatorium environments.  
*\*Standard drivers compatible with passive/sinking dimmers. Please contact Metalumen if active/sourcing dimmer support is required.*

WARRANTY

Metalumen will warrant defective luminaires for 5 years from date of purchase. Warranty is valid if luminaire is installed and used according to specification. If defective, Metalumen will send replacement boards or drivers at no cost along with detailed replacement instructions and instructions on how to return defective components to Metalumen.

PHOTOMETRIC DATA - 3500K, 80 CRI

Optics: **Meta Blanc**  
 IES File: **S4W-D-35K-4-MB-75**  
 Lumens: **790/ft** Wattage: **8.1/ft**  
 Efficacy: **97 LPW**

ZONAL LUMEN SUMMARY

Zone	Lumens	%Fixt
0-90	3161	100
90-180	0	0
0-180	3161	100

LUMINANCE DATA (CD/M2)

Vertical Angle	Horizontal Angle	
	0/180	90/270
85	4868	7919
75	6987	7914
65	7991	8664
55	8693	9221
45	9295	9802

PHOTOMETRIC CURVE  
100% Down

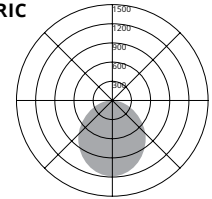

Optics: **Polycarbonate Lens**  
 IES File: **S4W-D-35K-4-PC-75**  
 Lumens: **791/ft** Wattage: **8.6/ft**  
 Efficacy: **87 LPW**

ZONAL LUMEN SUMMARY

Zone	Lumens	%Fixt
0-90	3226	100
90-180	0	0
0-180	3226	100

LUMINANCE DATA (CD/M2)

Vertical Angle	Horizontal Angle	
	0/180	90/270
85	2585	6586
75	5286	6573
65	6877	8266
55	8033	9331
45	9176	10290

PHOTOMETRIC CURVE  
100% Down

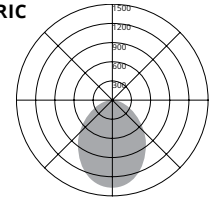

Photometric performance is measured and scaled in accordance with IESNA LM-79.