

RAIL 1.5 S1

RECESSED DRYWALL FLANGELSS . DIRECT

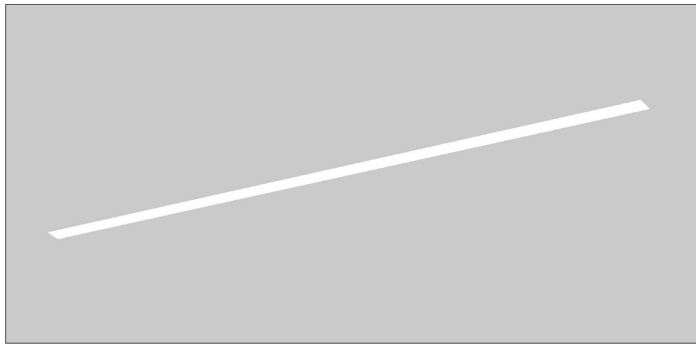

- Narrow 1.5 inch profile
- Integral driver
- 4', 8' and 12' lengths as well as continuous rows
- Continuous direct optics with no breaks



PART #:		DATE:	
PREP BY:		QTY:	
PROJECT:		NOTES:	
APPROVAL SIGNATURE:		DATE (DD/MM/YYYY):	

PERFORMANCE SUMMARY @ 3500K

		Meta Blanc (MB)
Light Level		75
Lumens per foot	80 CRI	766
	90 CRI	670
Wattage per foot		7.4
Efficacy (LPW)	80 CRI	103
	90 CRI	90.5
L70 Estimate (h)		≥ 60,000 hrs

See page 2 for the complete Light Level Performance chart.

OTHER RAIL PRODUCTS

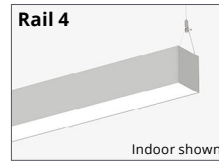
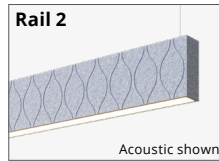

ORDERING LOGIC

Example Part Number: S1-35K-12-MB-W-501-DF-1-90

S1					MB					DF			
1	2	3	4	5	6	7	8	9	10	11	12	13	

1. SERIES	2. COLOR TEMP	3. LENGTH	4. PATTERN ¹	5. OPTICS	6. FINISH	
S1 Direct	30K 3000K 35K 3500K 40K 4000K	2 2 ft 8 8 ft 3 3 ft 9 9 ft 4 4 ft 10 10 ft 5 5 ft 11 11 ft 6 6 ft 12 12 ft 7 7 ft	GA Square GAxB Rectangle UAxBxC U-Shape LAxB L-Shape C Custom Pattern* _ None (leave space empty)	MB Meta Blanc	SA Satin Aluminum W White B Black C Custom Finish Specify RAL:	
	90 CRI is available under OPTIONS	RA Continuous Rows* Replace "A" with length in feet C Custom Length* _ None (leave space empty)	Standard Patterns Minimum Lengths A = 4 ft min. A = 4 ft min. B = 4 ft min. A = 3 ft min. B = 4 ft min. C = 3 ft min. A = 3 ft min. B = 3 ft min.	Meta Blanc: Opal diffuse lens		
			Custom Patterns* Lengths and a drawing of custom pattern are required on page 2 T-Shape Cross/X	Select corner: <input type="checkbox"/> Outside 90° <input type="checkbox"/> Inside 90° WALL		
7. LIGHT LEVEL / DRIVER	8. CIRCUITRY	9. MOUNTING	10. VOLTAGE	11. SENSORS	12. CONTROLS	13. OPTIONS
35 350 lm/f 50 500 lm/f 75 750 lm/f 100 1000 lm/f C Custom Range Specify lumens: (Total lumens between 350-1000 lm at 50 lm intervals)	1 1 Circuit EM Emergency / Night Light B Emergency Battery Pack ²	DF Recessed Drywall Flangeless	1 120 V 2 277 V 3 347 V 4 UNV (120 - 277V)	_ None (leave space empty)		90 90 CRI, High R9 _ None (leave space empty)

*Consult factory. | ¹ Pattern record drawings showing mounting locations will be sent out upon order. | ² Battery operates 4ft sections only.

- Select Driver: Factory option 0-10V, 1% Dimming
 LHE Lutron H-Series Hi-lume 1% EcoSystem LED Driver
 LSE Lutron 5-Series EcoSystem LED Driver

LIGHT LEVEL PERFORMANCE

3500K, 80 CRI, 0-10V Dimming (Standard)			
Optics	Meta Blanc		
Light Level	Lumens per foot	Wattage per foot	Efficacy (LPW)
35	364	3.4	107
50	521	5.0	105
75	766	7.4	103
100	1022	10.3	99

Lumen Adjustment Factor		
Color Temp	80 CRI	90 CRI
3000K	0.984	0.880
3500K	1.000	0.875
4000K	1.032	0.879

Metalumen's light level performance metrics are subject to manufacturers component tolerances.

PATTERNS

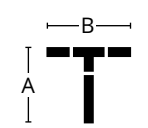
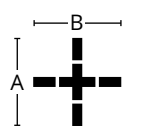
Select Pattern:	<input type="checkbox"/> T-SHAPE (C)	<input type="checkbox"/> CROSS / X-SHAPE (C)
Pattern Configuration		
Indicate Desired Lengths (ft)	A = B =	A = B =
Minimum Lengths	A = 3 ft B = 6 ft	A = 6 ft B = 6 ft

A custom pattern configuration drawing is required in the grid below

Approval drawings will be sent out upon order showing mounting locations.

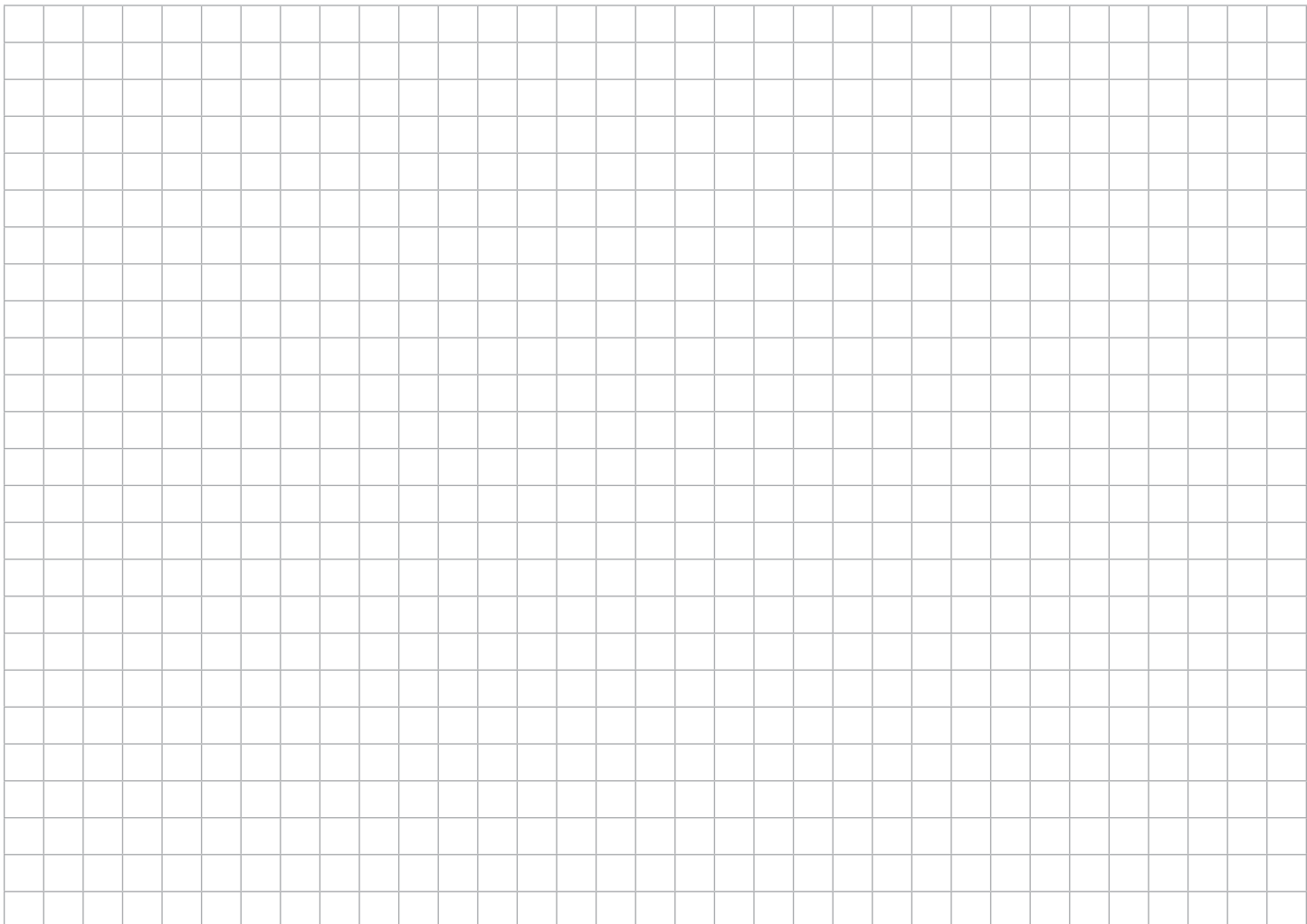

CROSS SECTIONS

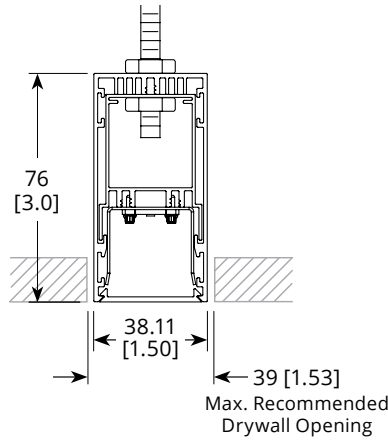

WIRING

Standard	Emergency / Night Light	Emergency Battery Pack

SPECIFICATIONS

Due to the Continuous Improvement Policy at Metalumen, we reserve the right to change our specifications without notice.

Housing: Rigid extruded aluminum body, 2.0mm (0.08”) nominal wall thickness. Zinc alloy die-cast end caps.
Optical System: Metalumen luminaires are designed to utilize leading edge LED technology combined with luminaire optimized reflectors and our custom diffusers, resulting in industry leading optical performance.

CRI: 83 (3500K) (80 minimum)
Lumen Maintenance: Minimum 50,000h with TM-21 lumen maintenance of 85% @ 25°C ambient temperature (calculated based on IESNA LM-80-08 LED test data). L70: ≥60,000hrs.
Finish: Satin Aluminum, white and black are standard options. For custom finish, contact factory.

Weight: 1.4 lb/ft or 0.6 kg/300mm.
Mounting: Mounting brackets provided.
Electrical: Factory prewired with easy wire quick connect sections.
Drivers: Metalumen offers 0-10V dimming* as a standard on our entire LED product offering. Dimming range is 1%-100%. Power factor is > 90%. Class 2 rating. All drivers are remote

mounted.
Approvals: All components are UL/ CSA/QPS recognized or listed. RoHS compliant. cULus pending.
Environment: Suitable for dry or damp locations.
**Standard drivers compatible with passive/sinking dimmers. Please contact Metalumen if active/sourcing dimmer support is required.*

WARRANTY

Metalumen will warrant defective luminaires for 5 years from date of purchase. Warranty is valid if luminaire is installed and used according to specification. If defective, Metalumen will send replacement boards or drivers at no cost along with detailed replacement instructions and instructions on how to return defective components to Metalumen.

PHOTOMETRIC DATA - 3500K, 80 CRI

Optics: **Meta Blanc**
 IES File: **S1-35K-4-MB-50**
 Lumens : **521/ft** Wattage: **5/ft**
 Efficacy: **105 LPW**

ZONAL LUMEN SUMMARY		
Zone	Lumens	%Fixt
0-90	2083	100
90-180	0	0
0-180	2083	100

LUMINANCE DATA (CD/M2)		
Vertical Angle	Horizontal Angle	
	0/180	90/270
85	8315	12662
75	11160	12539
65	12701	14186
55	14026	15355
45	15294	16519

PHOTOMETRIC CURVE
 100% Down

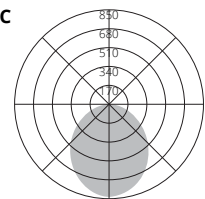

Photometric performance is measured and scaled in accordance with IESNA LM-79.